

NCP12510B65GEVB

65 W Notebook Off-line Adaptor with NCP12510 Evaluation Board User Manual



ON Semiconductor®

www.onsemi.com

Description

This evaluation board user manual describes the NCP12510B65GEVB board and its main parameters, i.e. efficiency, no-load input power consumption, EMI signature, transient responses, etc.

The evolution board is a flyback topology converter which provides output voltage 19 Vdc for output nominal current up to 3.5 A, therefore, the nominal output power is 65 W. Input voltage range is recommended from 90 Vac up to 265 Vac.

The switching of the converter is ensured by the NCP12510 – fixed-frequency current-mode PWM controller switching at 65 kHz. The frequency foldback down to 26 kHz is implemented for achievement the high efficiency during light load conditions. The skip cycle and low supply current of the controller ensures the very low no-load input power consumption (standby power) of the converter, which is less than 40 mW without indication LED on output.

The controller is also equipped with a lot of protections. The standard protection is over-current protection which disables the switching after fault timer is elapsed. This protection is activated when over-current or short-circuit conditions appear. In the case of damage of some component important for regulation, the controller is equipped with fast over-voltage protection on OPP pin (pin 3) and VCC pin (pin 5). The controller protects the whole converter against overheating by an NTC thermistor connected to the OPP pin (pin 3). The protection against high power capability of converter at high line is over-power protection. It is based on reducing the internal peak current setpoint depending on input voltage value.

EVAL BOARD USER'S MANUAL

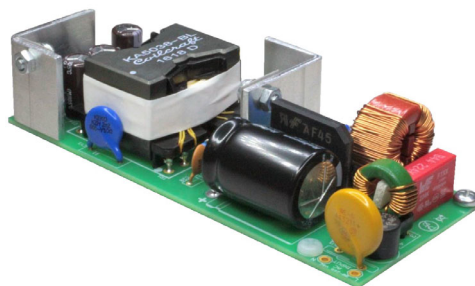

Key Features

- Excellent Standby Power Consumption
- High Efficiency
- High Robustness and High ESD Capabilities
- Wide Input Voltage Range (90 – 265 Vac)
- Low EMI Emissions
- Over-Current Protection
- Over-Temperature Protection
- Over-Voltage Protection
- Over-Power Protection

Table 1. GENERAL PARAMETERS

Device	Applications	Input Voltage	Nominal Output Voltage / Current	Output Power	V _{OUT} Ripple
NCP12510	Notebook Adaptors, Ac – dc converters for consumer electronics	90 – 265 Vac	19 Vdc / 3.5 A 4.5 A max limit	65 W	< 20 mV @ no load and min input voltage
Efficiency	Standby Power	Operating Temperature	Cooling	Topology	Board Size
~91%	20 mW @ 120 Vac 31 mW @ 230 Vac	0 – 50°C	Passive cooling	Flyback	111 x 48 x 21 mm

NCP12510B65GEVB

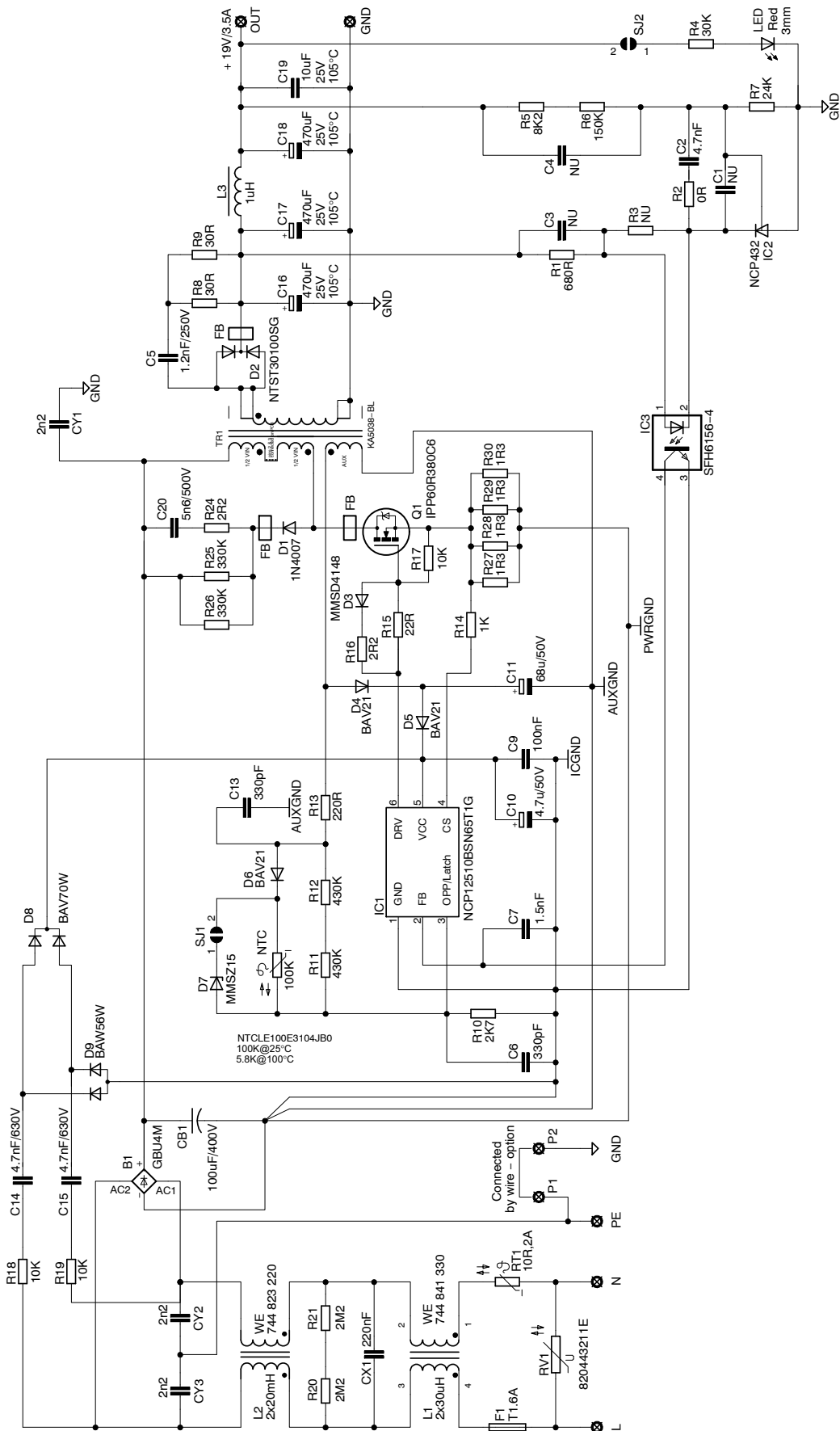

Figure 1. 65 W Notebook Off-line Adaptor with NCP12510 – Evolution Board

Detailed Descriptions of the Evaluation Board

The input of the converter is protected by the varistor RV1 as a differential mode lightning surge protection up to 6 kV. The fuse F1 is 1.6 A time-lag type fuse to withstand the inrush current. There is also installed NTC thermistor RT1 for inrush current limiting. The NTC RT1 was removed for the measurement in order not to affect the efficiency and standby measurement, etc.

The EMI filter consists from the common-mode power line chokes L1 and L2, X-capacitor CX1, which is complemented with discharge resistors R20, R21, and two Y-capacitors CY2, CY3. The center of CY2 and CY3 capacitors is connected to the PE terminal and also to the P1 terminal. The P1 terminal could be connected to the P2 terminal by a wire if the connection between PE terminal and output GND terminal is demanded.

The power stage primary side is a classical flyback topology and it consists mainly of the bulk capacitor CB1, transformer TR1 and power MOSFET transistor Q1. The ferrite bead FB is threaded on drain lead of the Q1 due to better EMI signature of the converter. The RCD snubber circuit is connected to the primary windings of the transformer TR1. The RCD snubber is composed of the resistor R24, capacitor C20, two resistors R25, R26 and diode D1 complemented with ferrite bead FB for better EMI. The controller NCP12510 senses the primary current directly as a voltage drop on resistors R27, R28, R29 and R30. These resistors are connected to the CS pin (pin 4) via resistor R14, which brings the slope compensation to prevent the sub-harmonic oscillations and stabilize the converter during CCM operation. Therefore, the value of R14 affects the maximum output current value of the converter at low line and determines the part of OPP characteristic for low line voltages. The collector of optocoupler IC3 is connected to the FB pin of NCP12510 controller. The capacitor C7 should be connected as close as possible to the FB pin for noise elimination. The MOSFET Q1 is driven via DRV pin. The resistors R15, R16 and diode D3 limits the gate current during turn-on and turn-off process of MOSFET and optimizes the EMI signature of the converter. Resistor R17 protects the MOSFET against unintended opening the transistor especially when the DRV signal potential is missing.

The supplying of NCP12510 controller is ensured by the electrolytic capacitor C10 with small ceramic capacitor C9 which should be as close as possible to the VCC pin. These capacitors are charged during startup phase via capacitive startup circuit composed of the components R18, R19, C14, C15, D8 and D9. After startup phase during normal switching operation mode, there is a voltage on auxiliary winding which charging bigger electrolytic capacitor C11, which is the main source of energy and it is separated from the capacitor C10 and the auxiliary windings by diodes D5 and D4. This capacitor is necessary for proper function of

the OCP latched controller version; it is the main energy source during short-circuit, so if there is no energy in it, the controller touches UVLO and the latch state never come, because UVLO protection is always auto-recovery.

Protections implemented in NCP12510 are OVP (over-voltage protection) on VCC pin, OCP (over-current protection) on CS pin and OVP, OTP (over-temperature protection) and OPP (over-power protection) on OPP/Latch pin. OPP protection limits the amount of delivered power to the output at high line by injecting the negative voltage from auxiliary windings to the OPP pin during on-time. The proper value of this negative voltage according to the input line voltage is set by voltage divider comprised of resistors R10, R11, R12 together with noise filter capacitor C6, which should be placed as close as possible to the OPP pin. The components, which ensure OVP/OTP protection, are divided by the diode D6 from auxiliary winding, because they are sensed during off-time. OTP protection is ensured by the NTC thermistor and OVP protection is ensured by the Zener diode D7 connected in series with solder jumper SJ1. The SJ1 helps to test the OVP protection on OPP pin and VCC pin separately. The resistor R13 and capacitor C13 form a low pass filter for better noise immunity from auxiliary winding. R13 and C13 should be placed as close as possible to the auxiliary winding.

The power stage secondary side consists of the Schottky diode D2, electrolytic capacitors C16, C17, C18, ceramic capacitor C19 and inductor L3. The ferrite bead FB is threaded on cathode lead of the D2 for better EMI signature. The RC snubber circuit, composed of capacitor C5 and resistors R8 and R9, is connected across the Schottky diode D2.

The regulation of output voltage is ensured by the regulation circuit with shunt regulator IC2 – NCP432. The optocoupler IC3 is driven via resistor R1, which determines the feedback loop gain. Resistor R3 biases the NCP432 in case that there is no current flowing through the optocoupler IC3. The feedback loop compensation network is created by resistor R2, capacitors C1, C2, C3, C4. The value of output voltage is set up by voltage divider comprised of resistors R5, R6, R7.

Connection between primary and secondary is ensured by the Y-capacitor CY1, which is connected between secondary ground and primary bulk voltage. This placing of CY1 helps to improve not only the EMI signature of the converter but also the immunity against common mode lightning surge. Terminals P1 and P2 allow make the connection between secondary ground GND and input earthing terminal PE. The connection should be made by a wire awg 18 or 0.75 mm².

The indication of the presence of output voltage is made by the red LED via resistor R34. The LED is connected to the output voltage via the solder jumper SJ2 for standby power measurement with or without the indication LED.

NCP12510B65GEVB

PCB layout

The PCB is made as a double layer FR4 board with 35 μm copper cladding.

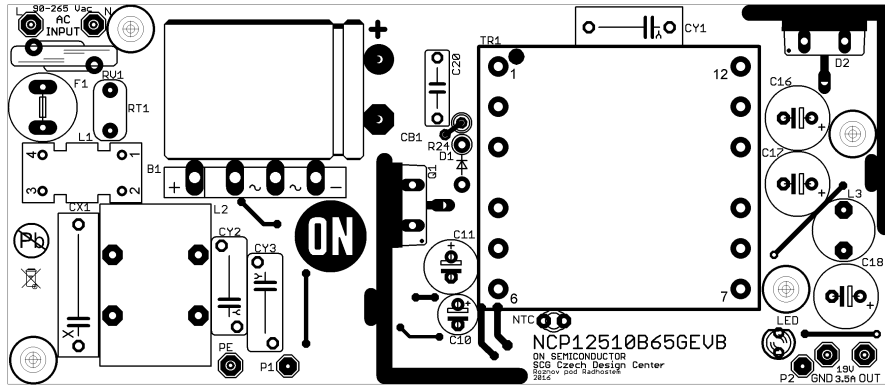

Figure 2. Evaluation Board – Top Side Components + Layer

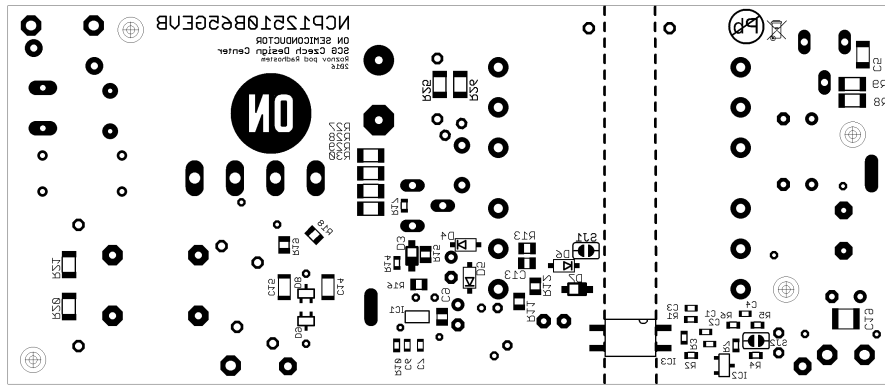

Figure 3. Evaluation Board – Bottom Side Components

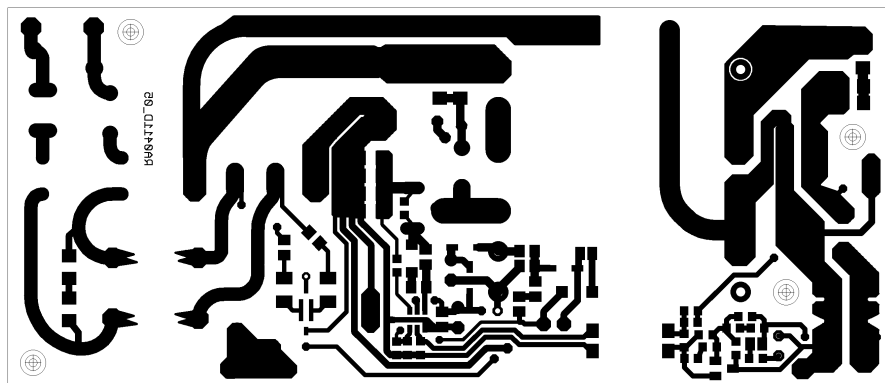

Figure 4. Evaluation Board – Bottom Side Layer

NCP12510B65GEVB

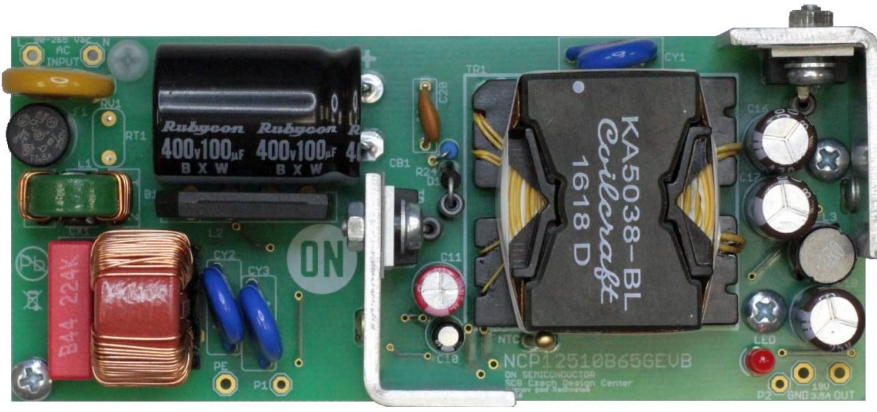

Figure 5. Evolution Board Photo – Top Side



Figure 6. Evolution Board Photo – Bottom Side

Measurements

The measurements show the performance of the NCP12510B65GEVB board.

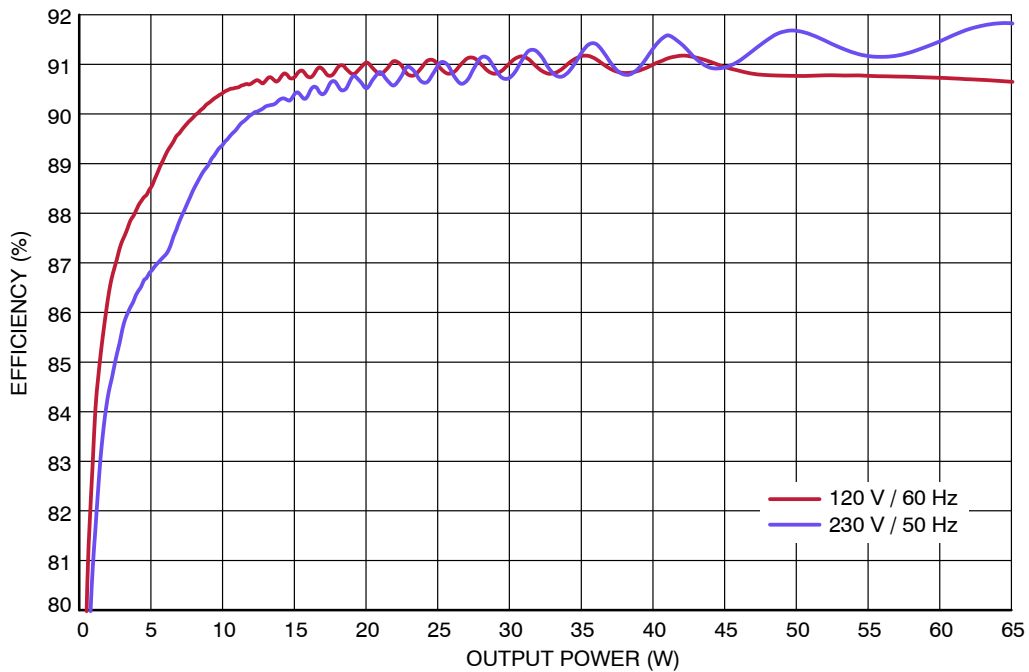

Figure 7. Efficiency Graph of NCP12510B65GEVB

NCP12510B65GEVB

Table 2. EFFICIENCY TABLE

Output Power [%]	10%	25%	50%	75%	100%	Calculated 4-point avg. Efficiency
Efficiency [%] @ $V_{IN} = 120 V_{rms}$	89.5%	90.9%	90.9%	90.9%	90.7%	90.9%
Efficiency [%] @ $V_{IN} = 230 V_{rms}$	87.5%	90.6%	91.1%	91.6%	91.8%	91.3%

Table 3. STANDBY POWER TABLE

Input Voltage [V_{rms}]	90 V	120 V	230 V	265 V
Standby power without indication LED [mW]	18 mW	20 mW	31 mW	36 mW
Standby power with indication LED [mW]	32 mW	34 mW	45 mW	51 mW

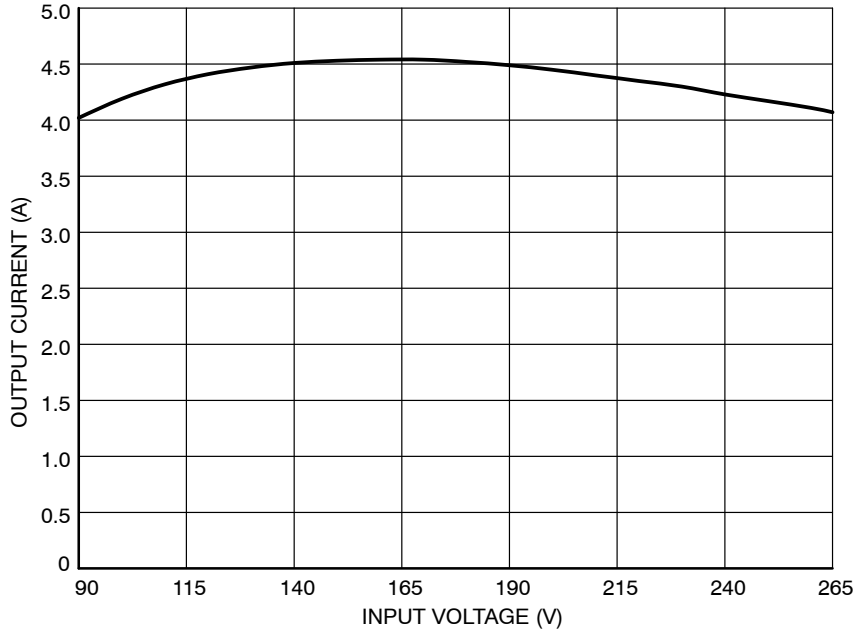

Figure 8. OPP Characteristic of NCP12510B65GEVB

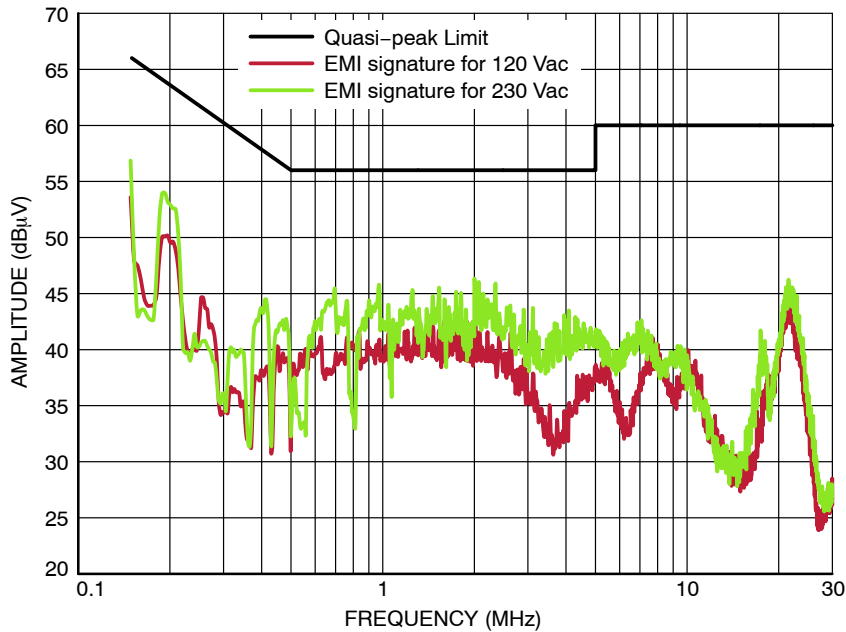

Figure 9. EMI Signature of NCP12510B65GEVB, $V_{IN} = 120/230 V_{ac}$, $P_{OUT} = 65 W$

NCP12510B65GEVB

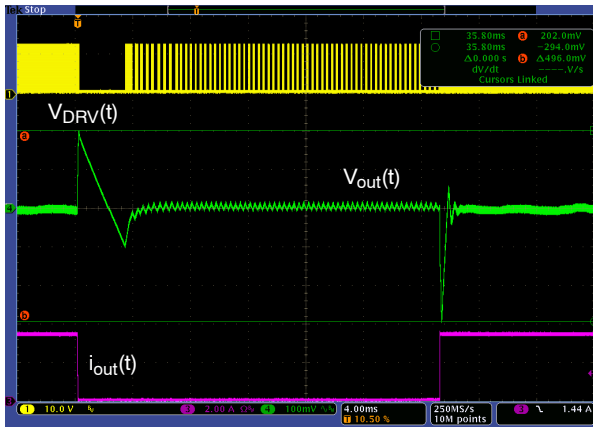

Figure 10. Transition Response – $I_{OUT} = 0.1 \text{ A}$ to 3.5 A , $V_{IN} = 120 \text{ V}$, Slew Rate $0.5 \text{ A}/\mu\text{s}$

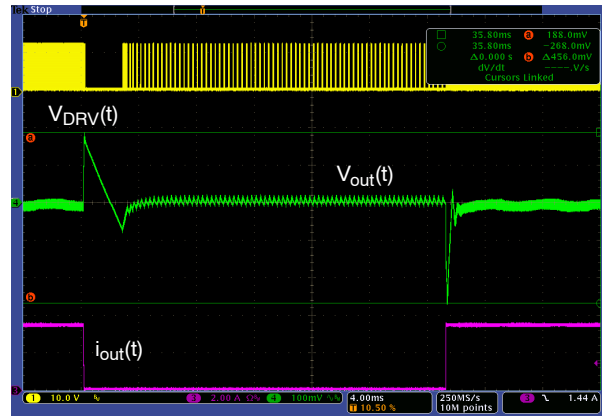

Figure 11. Transition Response – $I_{OUT} = 0.1 \text{ A}$ to 3.5 A , $V_{IN} = 230 \text{ V}$, Slew Rate $0.5 \text{ A}/\mu\text{s}$

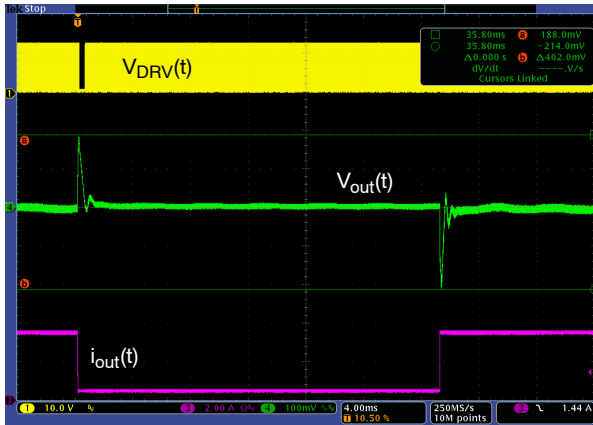

Figure 12. Transition Response – $I_{OUT} = 0.5 \text{ A}$ to 3.5 A , $V_{IN} = 120 \text{ V}$, Slew Rate $0.5 \text{ A}/\mu\text{s}$

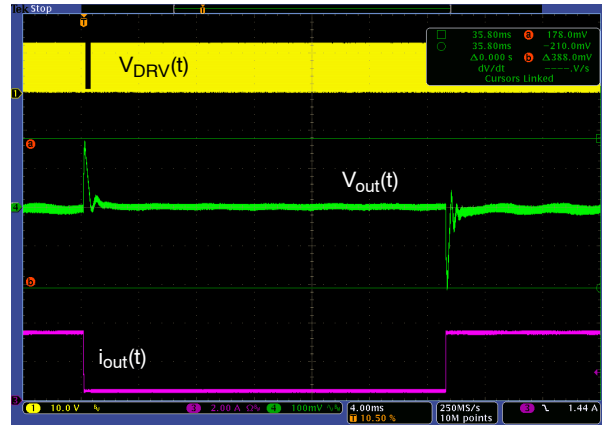

Figure 13. Transition Response – $I_{OUT} = 0.5 \text{ A}$ to 3.5 A , $V_{IN} = 230 \text{ V}$, Slew Rate $0.5 \text{ A}/\mu\text{s}$

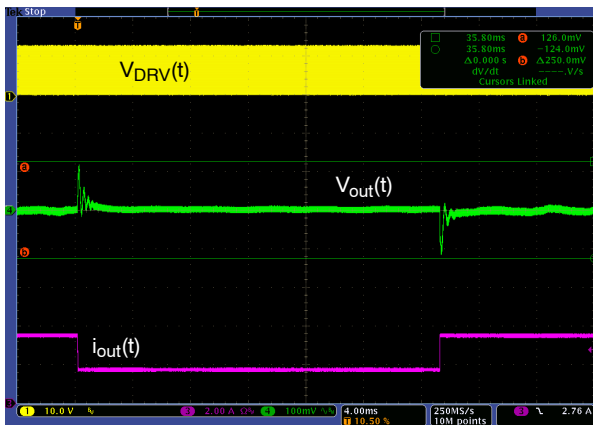

Figure 14. Transition Response – $I_{OUT} = 1.75 \text{ A}$ to 3.5 A , $V_{IN} = 120 \text{ V}$, Slew Rate $0.5 \text{ A}/\mu\text{s}$

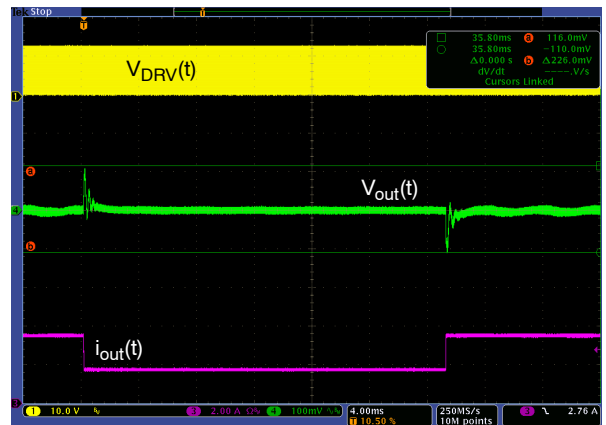

Figure 15. Transition Response – $I_{OUT} = 1.75 \text{ A}$ to 3.5 A , $V_{IN} = 230 \text{ V}$, Slew Rate $0.5 \text{ A}/\mu\text{s}$

NCP12510B65GEVB

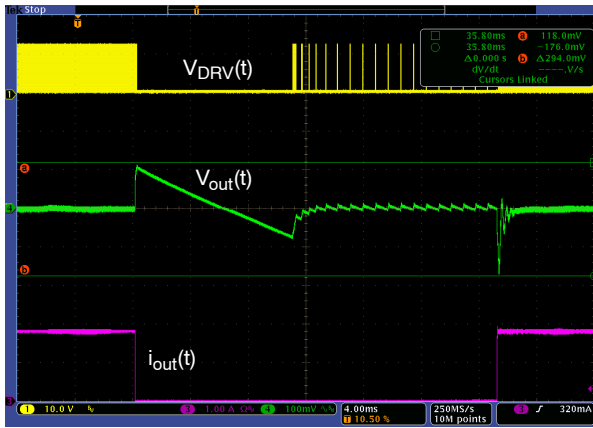

Figure 16. Transition Response – $I_{OUT} = 0.0 \text{ A}$ to 1.8 A , $V_{IN} = 120 \text{ V}$, Slew Rate $0.5 \text{ A}/\mu\text{s}$

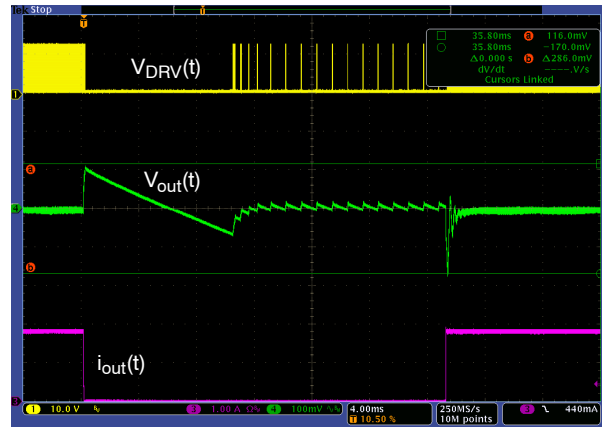

Figure 17. Transition Response – $I_{OUT} = 0.0 \text{ A}$ to 1.8 A , $V_{IN} = 230 \text{ V}$, Slew Rate $0.5 \text{ A}/\mu\text{s}$

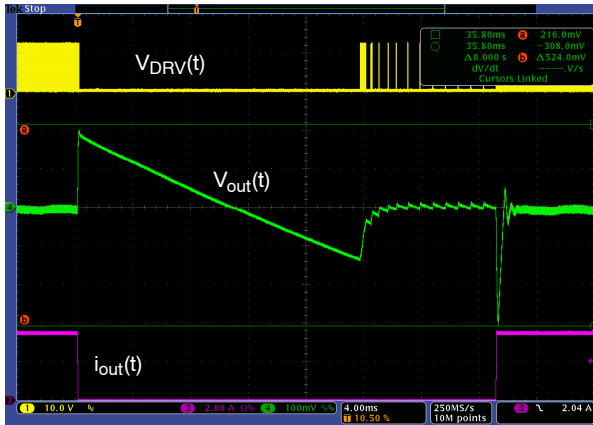

Figure 18. Transition Response – $I_{OUT} = 0.0 \text{ A}$ to 3.5 A , $V_{IN} = 120 \text{ V}$, Slew Rate $0.5 \text{ A}/\mu\text{s}$

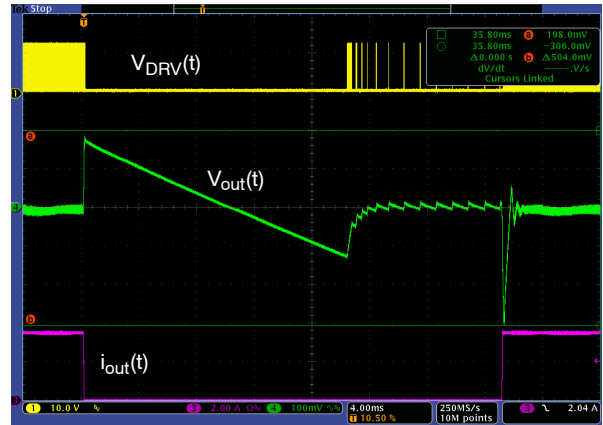

Figure 19. Transition Response – $I_{OUT} = 0.0 \text{ A}$ to 3.5 A , $V_{IN} = 230 \text{ V}$, Slew Rate $0.5 \text{ A}/\mu\text{s}$

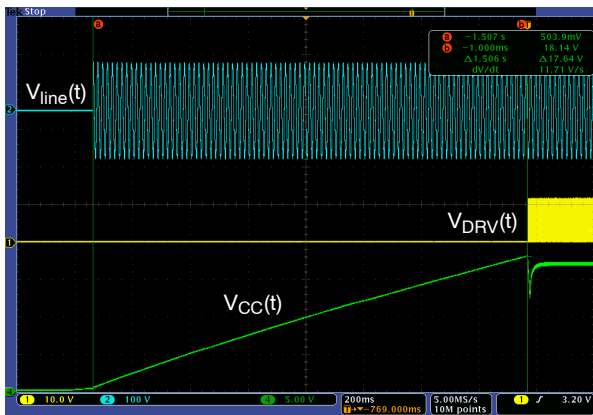

Figure 20. Startup Time – $V_{IN} = 90 \text{ V}$, $t_{startup} = 1.5 \text{ s}$

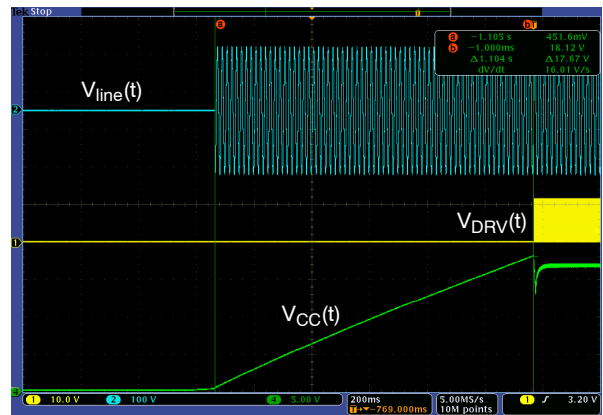

Figure 21. Startup Time – $V_{IN} = 120 \text{ V}$, $t_{startup} = 1.1 \text{ s}$

NCP12510B65GEVB

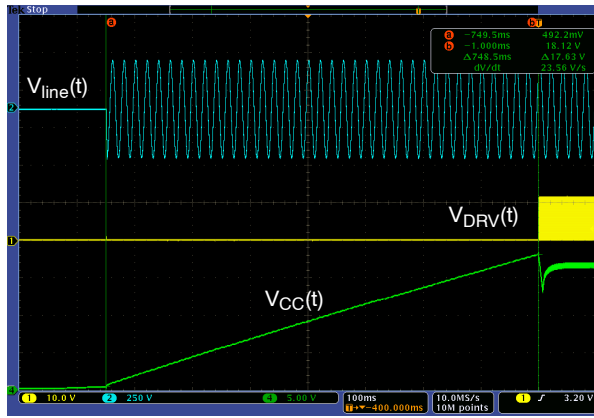

Figure 22. Startup Time – $V_{IN} = 230\text{ V}$, $t_{\text{startup}} = 0.75\text{ s}$

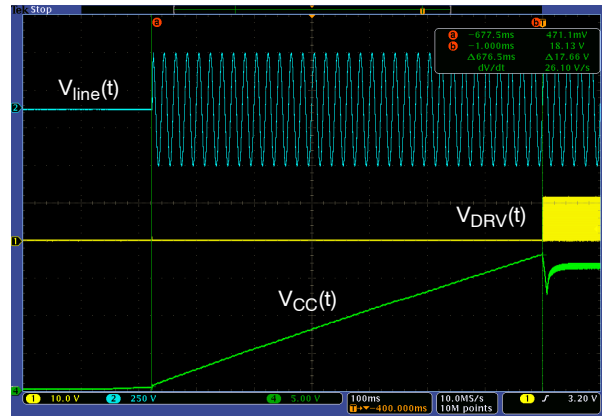

Figure 23. Startup Time – $V_{IN} = 265\text{ V}$, $t_{\text{startup}} = 0.68\text{ s}$

Table 4. BILL OF MATERIALS

Quantity	Parts	Value	Tolerance	Package	Description	Manufacturer	Manufacturer Part	Substitution Allowed
1	B1	GBU4M	-	GBU4S	Bridge Rectifiers 4A	Fairchild	GBU4M	Yes
0	C1, C3, C4	DNP	-	0603	Capacitor MLCC, SMD	-	-	Yes
1	C2	4.7nF	10%	0603	Capacitor MLCC, SMD	Various	Various	Yes
1	C5	1.2nF/250V	5%	1206	Capacitor MLCC, SMD	TDK	CGA5F4C0G2J122J085AA	Yes
1	C6	330pF	10%	0603	Capacitor MLCC, SMD	Various	Various	Yes
1	C7	1.5nF	10%	0603	Capacitor MLCC, SMD	Various	Various	Yes
1	C9	100nF	10%	0805	Capacitor MLCC, SMD	Various	Various	Yes
1	C10	4.7u/50V	-	Through Hole	Electrolytic Capacitor	Panasonic	EEA-GA1H4R7H	Yes
1	C11	68u/50V	-	Through Hole	Electrolytic Capacitor	Würth Elektronik	860020673014	Yes
1	C13	330pF	-	0805	Capacitor MLCC, SMD	Various	Various	Yes
2	C14, C15	4.7nF/630V	-	1206	Capacitor MLCC, SMD	Murata	GRM31BR72J472KW01L	Yes
3	C16, C17, C18	470uF/25V	-	Through Hole	Electrolytic Capacitor	United Chemi-Con	EKZN250ELL471MH15D	Yes
1	C19	10uF	10%	1210	Capacitor MLCC, SMD	Various	Various	Yes
1	C20	5.6nF/500V	-	Through Hole	Ceramic Leaded Capacitor	Various	Various	Yes
1	CB1	100uF/400V	-	Through Hole	Electrolytic Capacitor	Rubycon	400BXW100MEFR18X25	Yes
1	CX1	220nF/310V	-	Through Hole	X Capacitor	Würth Elektronik	890334025027	Yes
3	CY1, CY2, CY3	2.2nF/500V	-	Through Hole	Y Capacitor	Vishay	VY1222M47Y5UQ63V0	Yes
1	D1	1N4007	-	Through Hole	Standard diode	ON Semiconductor	1N4007RLG	No
1	D2	NTST30100SG	-	TO-220-3	Schottky diode, 30 A, 100 V	ON Semiconductor	NTST30100SG	No
1	D3	MMSD4148	-	SOD123	Switching diode	ON Semiconductor	MMSD4148T1G	No
3	D4, D5, D6	BAV21	-	SOD123	Small signal diode	Diodes Inc.	BAV21W-7-F	Yes
1	D7	MMSZ15	-	SOD123	Zener Diode	ON Semiconductor	MMSZ15T1G	No
1	D8	BAV70W	-	SOT323	Dual Common Cathode Diode	ON Semiconductor	BAV70WT1G	No
1	D9	BAW56W	-	SOT323	Dual Anode Cathode Diode	ON Semiconductor	BAW56WT1G	No
1	F1	T1.6A	-	Through Hole	Fuse	Bel Fuse	MRT 1.6 AMMO	Yes
3	FB	35@25MHz	-	-	Ferrite bead	Würth Elektronik	74270073	Yes
1	IC1	NCP12510B65	-	TSOP6	Flyback controller	ON Semiconductor	NCP12510BSN65T1G	No
1	IC2	NCP432	-	SOT23	Voltage reference	ON Semiconductor	NCP432BCSNT1G	No
1	IC3	SFH6156-4	-	SMD-4	Optocoupler	Vishay	SFH6156-4	Yes
1	L1	2x30 uH	-	Through Hole	Common Mode Choke, 30 uH, 3 A	Würth Elektronik	744841330	Yes
1	L2	2x20 mH	-	Through Hole	Common Mode Choke, 20 mH, 1.5 A	Würth Elektronik	744823220	Yes
1	L3	1 uH	-	Through Hole	Inductor 1 uH/7.5 A	Würth Elektronik	744772010	Yes

NCP12510B65GEVB

Table 4. BILL OF MATERIALS

Quantity	Parts	Value	Tolerance	Package	Description	Manufacturer	Manufacturer Part	Substitution Allowed
1	LED	3 mm	-	Through Hole, 3 mm	LED	Kingbright	WP710A10ID	Yes
1	NTC	100K	5%	Through Hole	NTC thermistor	Vishay	NTCLE100E3104JB0	Yes
1	Q1	600 V/10.6 A	-	TO-220-3	MOSFET N-Ch CoolMOS C6	Infineon Technologies	IPP60R380C6	Yes
1	R1	680R	1%	0603	Resistor, SMD	Various	Various	Yes
1	R2	0R	1%	0603	Resistor, SMD	Various	Various	Yes
0	R3	DNP	-	0603	Resistor, SMD	-	-	Yes
1	R4	30K	1%	0603	Resistor, SMD	Various	Various	Yes
1	R5	8K2	1%	0603	Resistor, SMD	Various	Various	Yes
1	R6	150K	1%	0603	Resistor, SMD	Various	Various	Yes
1	R7	24K	1%	0603	Resistor, SMD	Various	Various	Yes
2	R8, R9	30R	1%	1206	Resistor, SMD	Various	Various	Yes
1	R10	2K7	1%	0603	Resistor, SMD	Various	Various	Yes
2	R11, R12	430K	1%	0805	Resistor, SMD	Various	Various	Yes
1	R13	220R	1%	0805	Resistor, SMD	Various	Various	Yes
1	R14	1K	1%	0603	Resistor, SMD	Various	Various	Yes
1	R15	22R	1%	0805	Resistor, SMD	Various	Various	Yes
1	R16	2R2	1%	0805	Resistor, SMD	Various	Various	Yes
1	R17	10K	1%	0603	Resistor, SMD	Various	Various	Yes
2	R18, R19	10K	1%	0805	Resistor, SMD	Various	Various	Yes
2	R20, R21	2M	1%	1206	Resistor, SMD	Various	Various	Yes
1	R24	2R2	1%	Through Hole, 0207	Resistor, axial lead	Various	Various	Yes
2	R25, R26	330K	1%	1206	Resistor, SMD	Various	Various	Yes
4	R27, R28, R29, R30	1R3	1%	1206	Resistor, SMD	Various	Various	Yes
1	RT1	10R,2A	-	Through Hole	NTC inrush current limiter	Epcos	B57153S0100M000	Yes
1	RV1	820443211E	-	Through Hole	Varistor	Wurth Elektronik	820443211E	Yes
1	TR1	KA5038-BL	-	KA5038-BL	Flyback Transformer	CoilCraft	KA5038-BL	Yes

NOTE: All parts are Lead-free

onsemi, **Onsemi**, and other names, marks, and brands are registered and/or common law trademarks of Semiconductor Components Industries, LLC dba "**onsemi**" or its affiliates and/or subsidiaries in the United States and/or other countries. **onsemi** owns the rights to a number of patents, trademarks, copyrights, trade secrets, and other intellectual property. A listing of **onsemi**'s product/patent coverage may be accessed at www.onsemi.com/site/pdf/Patent-Marking.pdf. **onsemi** is an Equal Opportunity/Affirmative Action Employer. This literature is subject to all applicable copyright laws and is not for resale in any manner.

The evaluation board/kit (research and development board/kit) (hereinafter the "board") is not a finished product and is not available for sale to consumers. The board is only intended for research, development, demonstration and evaluation purposes and will only be used in laboratory/development areas by persons with an engineering/technical training and familiar with the risks associated with handling electrical/mechanical components, systems and subsystems. This person assumes full responsibility/liability for proper and safe handling. Any other use, resale or redistribution for any other purpose is strictly prohibited.

THE BOARD IS PROVIDED BY ONSEMI TO YOU "AS IS" AND WITHOUT ANY REPRESENTATIONS OR WARRANTIES WHATSOEVER. WITHOUT LIMITING THE FOREGOING, ONSEMI (AND ITS LICENSORS/SUPPLIERS) HEREBY DISCLAIMS ANY AND ALL REPRESENTATIONS AND WARRANTIES IN RELATION TO THE BOARD, ANY MODIFICATIONS, OR THIS AGREEMENT, WHETHER EXPRESS, IMPLIED, STATUTORY OR OTHERWISE, INCLUDING WITHOUT LIMITATION ANY AND ALL REPRESENTATIONS AND WARRANTIES OF MERCHANTABILITY, FITNESS FOR A PARTICULAR PURPOSE, TITLE, NON-INFRINGEMENT, AND THOSE ARISING FROM A COURSE OF DEALING, TRADE USAGE, TRADE CUSTOM OR TRADE PRACTICE.

onsemi reserves the right to make changes without further notice to any board.

You are responsible for determining whether the board will be suitable for your intended use or application or will achieve your intended results. Prior to using or distributing any systems that have been evaluated, designed or tested using the board, you agree to test and validate your design to confirm the functionality for your application. Any technical, applications or design information or advice, quality characterization, reliability data or other services provided by **onsemi** shall not constitute any representation or warranty by **onsemi**, and no additional obligations or liabilities shall arise from **onsemi** having provided such information or services.

onsemi products including the boards are not designed, intended, or authorized for use in life support systems, or any FDA Class 3 medical devices or medical devices with a similar or equivalent classification in a foreign jurisdiction, or any devices intended for implantation in the human body. You agree to indemnify, defend and hold harmless **onsemi**, its directors, officers, employees, representatives, agents, subsidiaries, affiliates, distributors, and assigns, against any and all liabilities, losses, costs, damages, judgments, and expenses, arising out of any claim, demand, investigation, lawsuit, regulatory action or cause of action arising out of or associated with any unauthorized use, even if such claim alleges that **onsemi** was negligent regarding the design or manufacture of any products and/or the board.

This evaluation board/kit does not fall within the scope of the European Union directives regarding electromagnetic compatibility, restricted substances (RoHS), recycling (WEEE), FCC, CE or UL, and may not meet the technical requirements of these or other related directives.

FCC WARNING – This evaluation board/kit is intended for use for engineering development, demonstration, or evaluation purposes only and is not considered by **onsemi** to be a finished end product fit for general consumer use. It may generate, use, or radiate radio frequency energy and has not been tested for compliance with the limits of computing devices pursuant to part 15 of FCC rules, which are designed to provide reasonable protection against radio frequency interference. Operation of this equipment may cause interference with radio communications, in which case the user shall be responsible, at its expense, to take whatever measures may be required to correct this interference.

onsemi does not convey any license under its patent rights nor the rights of others.

LIMITATIONS OF LIABILITY: **onsemi** shall not be liable for any special, consequential, incidental, indirect or punitive damages, including, but not limited to the costs of requalification, delay, loss of profits or goodwill, arising out of or in connection with the board, even if **onsemi** is advised of the possibility of such damages. In no event shall **onsemi**'s aggregate liability from any obligation arising out of or in connection with the board, under any theory of liability, exceed the purchase price paid for the board, if any.

The board is provided to you subject to the license and other terms per **onsemi**'s standard terms and conditions of sale. For more information and documentation, please visit www.onsemi.com.

PUBLICATION ORDERING INFORMATION

LITERATURE FULFILLMENT:

Email Requests to: orderlit@onsemi.com

onsemi Website: www.onsemi.com

TECHNICAL SUPPORT

North American Technical Support:

Voice Mail: 1 800-282-9855 Toll Free USA/Canada

Phone: 011 421 33 790 2910

Europe, Middle East and Africa Technical Support:

Phone: 00421 33 790 2910

For additional information, please contact your local Sales Representative